

SE812 INDOOR SIREN



The Indoor Siren is a Z-Wave™ enabled device and is fully compatible with any Z-Wave™ enabled network. Z-Wave™ enabled devices displaying the Z-Wave™ logo can also be used with it regardless of the manufacturer, and ours can also be used in other manufacturer's Z-Wave™ enabled networks. Inclusion of this Indoor Siren on other manufacturer's Wireless Controller menu allows a full alarm condition to be generated once a connected Z-Wave™ enabled device has been triggered. Z-Wave™ enabled devices (refer to nodes) in the system also act as repeaters, so as to re-transmit the RF signal to ensure that the signal is received by its intended destination by routing the signal around obstacles and radio dead spots.

The Indoor Siren integrates both functions of siren and strobe into one unit. Two sound levels, 100dB and 90dB, are available for selection. When it receives a RF command, it will either activate its sounder and flash lights or stop these visual and audible alarm indications.

Product Overview

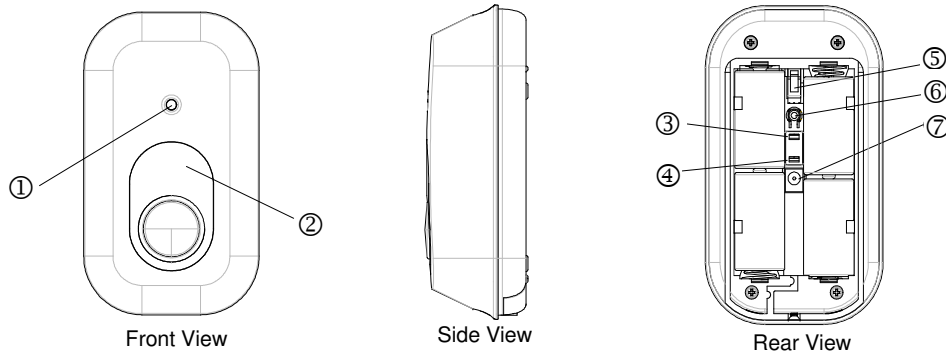

① LED Indicator	⑤ Tamper Switch
② Red Strobe Light	⑥ Link Key
③ Two-Phase Sound Jumper Link	⑦ DC Jack
④ Tamper Jumper Link	

Include to or Exclude from a Z-Wave™ Network

In the rear casing, there is a link key which is used to carry out inclusion, exclusion or reset. When power is first applied, its orange LED flashes on and off alternately and repeatedly at 2-second intervals. It implies that it has not been assigned a node ID and cannot work with Z-Wave™ devices. The Siren will stay "awake" for 10 minutes when power is first applied to allow time for configuration. Please get familiar with the terms below before starting the operations.

Function	Description
Inclusion	Add a Z-Wave enabled device (e.g. Siren) to Z-Wave network.
Exclusion	Delete a Z-Wave enabled device (e.g. Siren) from the network.
Association	After inclusion, you have to define the relationship between devices. Through association, device can be assigned as master/slave, and specify which slave is going to be controlled by which master.
Reset	Restore Siren to factory default.

The table below lists an operation summary of basic Z-Wave functions. Please refer to the instructions for your Z-Wave™ Certificated Primary Controller to access the setup function, and to include/exclude/associate devices.

Function	Description	LED & Beep Indication
No node ID	The Z-Wave Controller does not allocate a node ID to the Siren.	LED: 2-second on, 2-second off; Beep: 0.1-second on, 9.9-second off
Inclusion	1. Have Z-Wave Controller entered inclusion mode.	Green LED is on and Siren beeps when link key is pressed.
	2. Pressing link key 3 times within 1.5 seconds will enter inclusion mode.	
Exclusion	1. Have Z-Wave Controller entered exclusion mode.	Green LED is on and Siren beeps when link key is pressed.
	2. Pressing link key 3 times within 1.5 seconds will enter exclusion mode.	
	Node ID has been excluded.	
Reset	1. Pressing link key 3 times within 1.5 seconds will enter reset mode.	Orange LED is on and Siren beeps when link key is pressed.
	2. Within 1 second, press link key again for 5 seconds until LED is off.	One long beep is on for 5 seconds, and orange LED is off.
	3. IDs are excluded; restore to factory default.	

Function	Description	LED & Beep Indication
Association	1. Have Z-Wave Controller entered association mode	Green LED is on and Siren beeps when link key is pressed.
	2. Pressing link key 3 times within 1.5 seconds will enter association mode.	
	3. There is one grouping (Grouping 1). Refer to Z-Wave's Group as described on page 3.	
* Including a node ID allocated by Z-Wave Controller means inclusion. Excluding a node ID allocated by Z-Wave Controller means exclusion. * Failure or success in including/excluding the node ID can be viewed from the Z-Wave Controller.		

Installation

The Siren is suitable for mounting in dry interior locations only. Please follow these directions when first setting up, or for the purpose of battery replacing.

1. Undo and remove the fixing screws from the bottom edge of the Indoor Siren and remove the rear cover (FIGURE 1 & 2).
2. Insert four LR14 1.5V size alkaline batteries to the battery compartment, ensuring correct polarity is put (FIGURE 3).

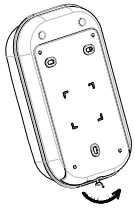

FIGURE 1

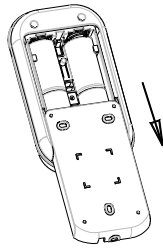

FIGURE 2

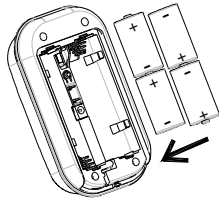

FIGURE 3

Note: You can use power adapter instead of batteries. The power adapter is an optional accessory. A cable track is set inside the unit for you to secure the power adapter. To install the power adapter, connect the plug of power adapter to the DC jack inside the unit. Route the cable along the cable track (FIGURE 4 & 5).

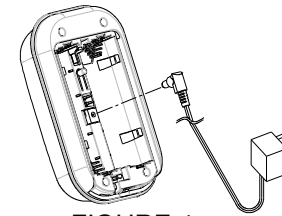

FIGURE 4

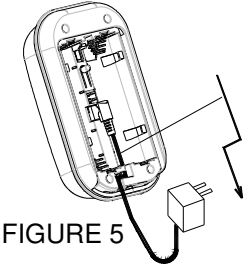

FIGURE 5

3. Using the rear cover as a template, mark the positions of three fixing holes on the wall. Fasten the rear cover to the wall using the screws and wall plugs provided (FIGURE 6).
4. Slide the unit down to the rear cover and lock the screw clockwise (FIGURE 7).

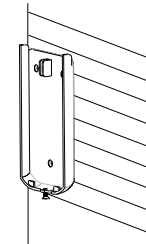

FIGURE 6

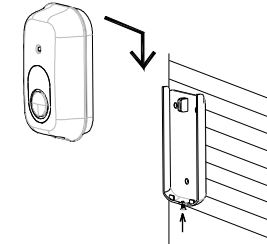

FIGURE 7

Operation

Two jumper links are disposed inside the Siren: Two-Phase Sound Jumper Link and Tamper Jumper Link (FIGURE 8). You can enable or disable the jumper link by fitting it on or removing it (FIGURE 9).

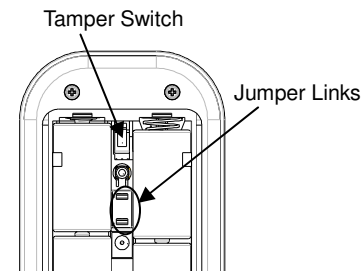

FIGURE 8

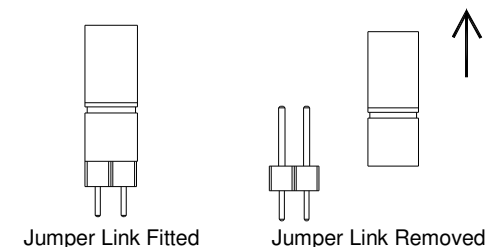

FIGURE 9

Tamper switch is designed to prevent Siren from being forcibly removed from the wall. Three seconds after it is pressed will enable the function of tamper protection. Removing the unit from the rear cover will release the tamper switch and generate a full alarm condition – strobe light flashes and alarm sounds for 3 minutes.

Programming

The following information is for someone that has some experience setting up a Z-Wave system or someone that has computer software running a Z-Wave controller.

1. Z-Wave's Groups (Association Command Class Version 2)

The Indoor Siren can be set to send reports to associated Z-Wave devices. It supports one association group with 5 nodes support for Grouping 1. For Grouping 1, the Siren will emit reports including POWER_APPLIED, Tamper Trigger Report and Battery & Low Battery Report.

1-1 POWER_APPLIED command

When power is applied, it will send ALARM_REPORT command to nodes of Grouping 1 to inform the devices that the Siren is powered up.

ALARM_REPORT Command [Command Class Alarm, Alarm Report, Type = 0x02, Level = 0x01]
--

1-2 Tamper Trigger Report

When tamper switch is triggered, Siren will send ALARM_REPORT command to nodes of Grouping 1 to inform the devices that the Siren has been triggered.

ALARM_REPORT Command [Command Class Alarm, Alarm Report, Type = 0x03, Level = 0x01]
--

1-3 Battery & Low Battery Report

When the battery level of the Siren drops to an unacceptable level, the Siren will flash red LED once every 30 seconds and send Broadcast command to the network.

ALARM_REPORT Command [Command Class Alarm, Alarm Report, Type = 0x01, Level = 0x01]
--

The users can also enquire the battery status of the Siren by sending BATTERY_GET command via controller. Once the Siren receives the command, it will return BATTERY_REPORT command. If the unit is in low battery status, a Battery_Level = 0xFF (255) command will be sent to the Z-Wave Controller.

BATTERY_REPORT Command [Command Class Battery, Battery Report, Battery Level = 20%-100%]

2. Basic Command Class / Binary Switch Command Class

The Siren will respond to BASIC and BINARY commands that are part of the Z-Wave system.

2-1 BASIC_SET/SWITCH_BINARY_SET

Upon receipt of the following commands from a Z-Wave Controller, the Siren will either generate a full alarm condition (on) or stop the full alarm condition (off).

[Command Class Basic, Basic Set, Value = 0xFF]: the Siren generates a full alarm condition by flashing strobe light and sounding alarm for 3 minutes.

[Command Class Basic, Basic Set, Value = 0]: the Siren stops full alarm condition.
--

[Command Class Switch Binary, Switch Binary Set, Value = 0xFF]: the Siren generates a full alarm condition by flashing strobe light and sounding alarm for 3 minutes.

[Command Class Switch Binary, Switch Binary Set, Value = 0x00]: the Siren stops full alarm condition.

2-2 BASIC_GET/BINARY_SWITCH_GET

Upon receipt of the following commands from a Z-Wave Controller, the Siren will report its On/Off status to the Controller.

Basic Get Command: [Command Class Basic, Basic Get]

Basic Report Command: Report OFF: [Command Class Basic, Basic Report, Value = 0x00] Report ON: [Command Class Basic, Basic Report, Value = 0xFF]
--

Binary Switch Get Command: [Command Class Switch Binary, Switch Binary Get]

Binary Switch Report Command
 Report OFF:
[Command Class Switch Binary, Switch Binary Report, Value =0x00]
 Report ON:
[Command Class Switch Binary, Switch Binary Report, Value = 0xFF]

Note: To execute the command of BASIC_SET/SWITCH_BINARY_SET, BASIC_GET/BINARY_SWITCH_GET and BATTERY_GET, the notes in the network must support the function of Z-Wave Wake Up Beam in order to wake the Siren up from sleep status.

3. Command Classes

The Siren supports Command Classes including...

- * COMMAND_CLASS_BASIC * COMMAND_CLASS_SWITCH_BINARY
- * COMMAND_CLASS_VERSION * COMMAND_CLASS_ASSOCIATION_V2
- * COMMAND_CLASS_BATTERY * COMMAND_CLASS_ALARM
- * COMMAND_CLASS_MANUFACTURER_SPECIFIC

Troubleshooting

Symptom	Possible Cause	Recommendation
LED cannot be displayed or Siren not working	1. Run out of battery power. 2. Check if reverse battery polarity	1. Replace a new battery 2. Refit the battery with correct polarity
	The Siren is out of order	Don't open the Siren; send it to the local retailer.

Specifications*

Power Adapter (optional)	6V DC/600mA
Operating Frequency	908.42 (SE812-2) / 921.42 MHz (SE812-9)
Battery Type	1.5V LR14 size x 4
Battery Life	1 year**
Operating Range	Up to 30 meters line of sight (indoor)
ZDK Version	V5.02

*Specifications are subject to change without notice

**1 trigger per day

A501111859R01



Federal Communication Commission Interference Statement

This equipment has been tested and found to comply with the limits for a Class B digital device, pursuant to Part 15 of the FCC Rules. These limits are designed to provide reasonable protection against harmful interference in a residential installation. This equipment generates, uses and can radiate radio frequency energy and, if not installed and used in accordance with the instructions, may cause harmful interference to radio communications. However, there is no guarantee that interference will not occur in a particular installation. If this equipment does cause harmful interference to radio or television reception, which can be determined by turning the equipment off and on, the user is encouraged to try to correct the interference by one of the following measures:

- Reorient or relocate the receiving antenna.
- Increase the separation between the equipment and receiver.
- Connect the equipment into an outlet on a circuit different from that to which the receiver is connected.
- Consult the dealer or an experienced radio/TV technician for help.

This device complies with Part 15 of the FCC Rules. Operation is subject to the following two conditions: (1) This device may not cause harmful interference, and (2) this device must accept any interference received, including interference that may cause undesired operation.

FCC Caution: Any changes or modifications not expressly approved by the party responsible for compliance could void the user's authority to operate this equipment.

This transmitter must not be co-located or operating in conjunction with any other antenna or transmitter.

WARNING:

Do not dispose of electrical appliances as unsorted municipal waste, use separate collection facilities.

Contact your local government for information regarding the collection systems available.

If electrical appliances are disposed of in landfills or dumps, hazardous substances can leak into the groundwater and get into the food chain, damaging your health and well-being.

When replacing old appliances with new ones, the retailer is legally obligated to take back your old appliance for disposal at least for free of charge.